

SPEND LESS TIME WAITING.
AND MORE TIME PUMPING.



FINISH THOMPSON INC.

Big on power yet short on energy consumption, the SP Series from Finish Thompson is one of the most versatile—and economical—centrifugal pumps on the market.

Backed by an industry best five-year warranty, it's also one of the most reliable.

The exclusive SP Series combines deep-lift capabilities (up to 25 feet/7.6 meters) and lightning-fast priming (18 feet/4.6 meters in 90 seconds) with the advantages of magnetic drive technology—ensuring ease of operation with no seal replacement, no leaks and the capability to run-dry without damage.

What's more, its innovative design and corrosion-resistant materials make the SP Series ideal for handling even the most difficult applications.





INTRODUCING THE NEW SP SERIES.

SELF-PRIMING
MAGNETIC
DRIVE PUMPS.

PRIME UP TO
18 FEET IN 90
SECONDS.

RUN WORRY
FREE FOR YEARS.



FINISH THOMPSON INC.

PRINCIPLES OF SELF-PRIMING

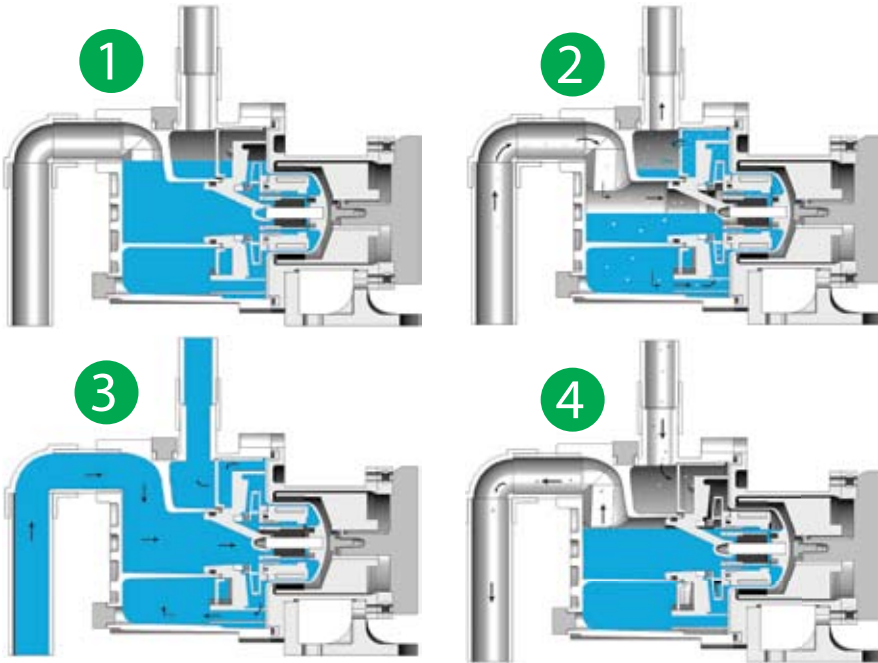

1 During pump installation, the priming housing is filled through the fill port.

2 As priming begins, air in the suction piping mixed with liquid in the priming chamber forms a vacuum in the inner volute. As they separate, the air rises out of the discharge piping while the liquid returns to the priming chamber.

3 The circulation process continues until liquid replaces all the air in the suction piping, beginning the pumping process.

4 When the pump is shut off, the priming chamber's gooseneck design ensures that enough liquid is retained for efficient re-priming.

APPLICATIONS

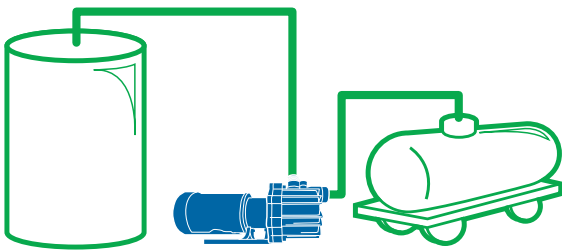

1 Transfer from top of rail cars or tanker trucks to bulk storage.

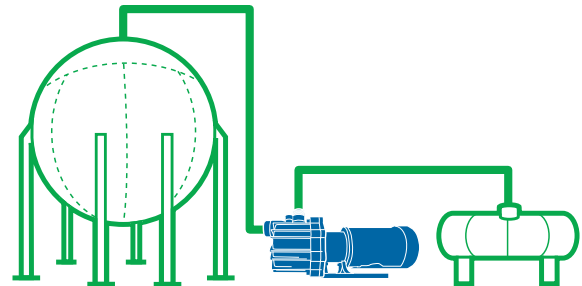

2 Transfer from bulk storage to process or day tanks.

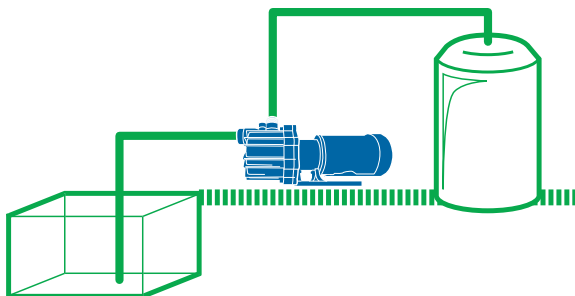

3 Pump from underground sumps or pits to treatment tanks.

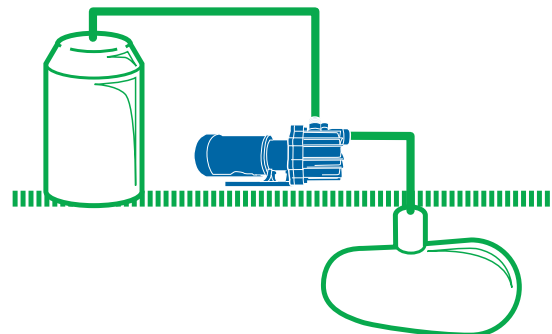

4 Pump from underground storage tanks to process or day tanks.

CAPABILITIES

- + Retains fluid for re-priming when shut off without a check valve
- + Runs without damage in absence of continuous flow
- + Provides up to 25 feet (7.6 meters) of lift*
- + Primes 18 feet (4.6 meters) in 90 seconds**
- + High working pressure—up to 90 psi (6.2 bar)
- + High specific gravity handling—over 1.8***
- + Maximum Temperature:
Polypropylene—180° F (82° C);
PVDF—220° F (104° C)

FEATURES

- + Five-year warranty
- + Polypropylene or PVDF construction
- + Sealless mag drive
- + Powerful neodymium magnets
- + Close-coupled with back pullout design
- + Mounts to NEMA and IEC motor frames
- + Replaceable shaft
- + ISO 1940 G2.5 balancing
- + CE certified

APPLICATIONS

- + Sumps
- + Underground storage tanks
- + Rail cars
- + Tanker trucks
- + Over-the-wall applications
- + Tanks with an opening on top
- + Piping systems that tend to have trapped or entrained air
- + When run dry protection is needed

* Lift determined on fresh, cold water with 1 1/2" Schedule 40 pipe.

** With maximum diameter impeller.

*** Specific gravity affects lift capability. Divide 25 feet (7.6 meters) by the specific gravity to determine maximum lift.

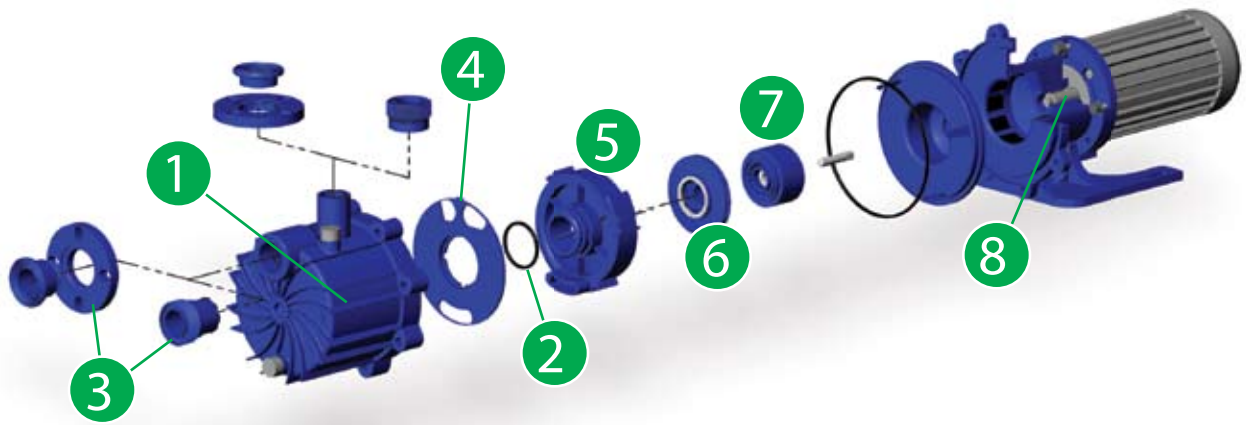

1. Thermoplastic Priming Chamber

Functions as a fluid reservoir and features molded-in “gooseneck” suction passage eliminating the need for internal check valves. Integral fill and drain ports are standard. Available in GF-PP or CF-PVDF for optimal corrosion resistance.

2. O-ring

Creates airtight seal between the inner volute and the “gooseneck” suction passage. Helps the pump maintain the vacuum required for proper priming.

3. Multiple Connections

NPT or BSP threads, raised face adjustable flanges or union.

4. Separator Plate

Acts as a barrier between the low velocity fluid reservoir and the high velocity area in the rear of the priming chamber. Openings allow liquid to flow to the impeller and discharge the air/liquid mixture created during priming back into the fluid reservoir.

5. Inner Volute

Houses the rotating impeller. Special design allows air to be efficiently removed from the suction passages for fast priming.

6. Multiple Impeller Diameters

Allows hydraulic requirements to be precisely met. Two-piece impeller design allows impeller to be changed without having to replace inner drive.

7. Run Dry System

The SP can run dry without damage when equipped with a chemical grade carbon bushing in optimum operating conditions. This helps protect the pump from operator errors and system upsets.

8. Easy Set Outer Drive

Measurement-free outer drive ensures optimum magnet alignment and easy motor installation.

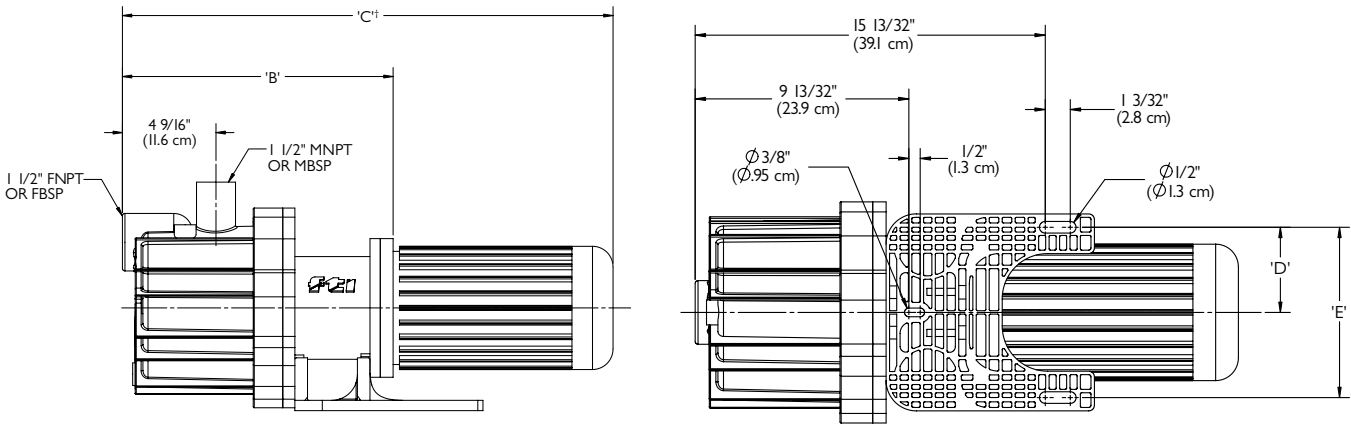
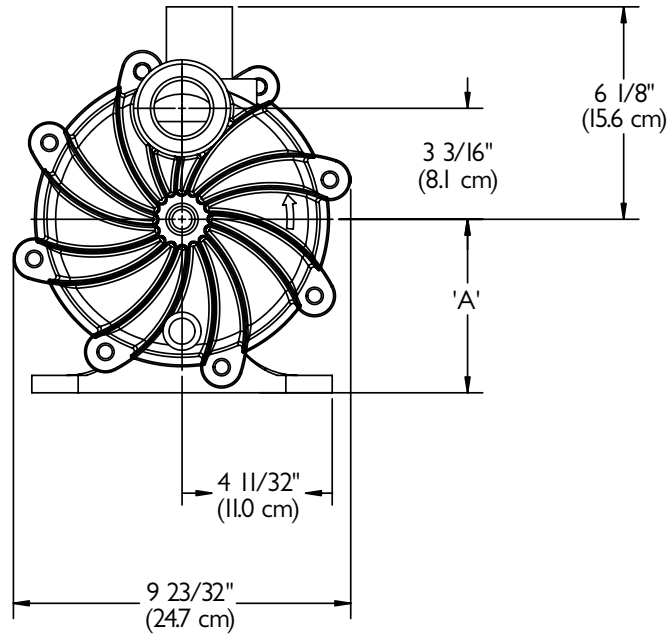

Also available 1-1/2" x 1-1/2" 150 lb. ANSI-ISO PN20/PN40 flange or 50 mm x 50 mm union connection

Motor Frame	A	B	C [†]	D	E	Weight - lbs. [kg] [*]	
						PP	PVDF
NEMA 56C	5" [12.7 cm]	12-9/16" [31.9 cm]	24-9/16" [62.4 cm]	3-3/4" [9.5 cm]	7-1/2" [19.1 cm]	25 [11.3]	30 [13.6]
NEMA 145	5" [12.7 cm]	12-9/16" [31.9 cm]	23-5/16" [59.2 cm]	3-3/4" [9.5 cm]	7-1/2" [19.1 cm]	25 [11.3]	30 [13.6]
NEMA 184	5" [12.7 cm]	13-7/16" [34.4 cm]	25-11/16" [66.6 cm]	3-3/4" [9.5 cm]	7-1/2" [19.1 cm]	26 [11.8]	31 [14.1]
IEC 80 w/B14 or B5**	5" [12.7 cm]	13-3/16" [33.5 cm]	23-23/32" [60.2 cm]	3-3/4" [9.5 cm]	7-1/2" [19.1 cm]	25.5 [11.6]	30.5 [13.8]
IEC 90 w/B14 or B5**	5" [12.7 cm]	13-3/16" [33.5 cm]	23-7/8" [60.6 cm]	3-3/4" [9.5 cm]	7-1/2" [19.1 cm]	25.5 [11.6]	30.5 [13.8]
IEC 100 w/B14	5" [12.7 cm]	13-1/4" [33.7 cm]	25-13/32" [64.5 cm]	3-5/32" [8.0 cm]	6-10/32" [16.0 cm]	25.5 [11.6]	30.5 [13.8]
IEC 112 w/B14	5" [12.7 cm]	13-1/4" [33.7 cm]	25-29/32" [65.8 cm]	3-3/4" [9.5 cm]	7-1/2" [19.1 cm]	25.5 [11.6]	30.5 [13.8]
IEC 100 w/B5**	3-15/16" [10.0 cm]	13-1/4" [33.7 cm]	25-25/32" [65.5 cm]	3-5/32" [8.0 cm]	6-10/32" [16.0 cm]	31.5 [14.3]	36.5 [16.6]
IEC 112 w/B5**	4-13/32" [11.2 cm]	13-1/4" [33.7 cm]	26-5/8" [67.6 cm]	3-3/4" [9.5 cm]	7-1/2" [19.1 cm]	31.5 [14.3]	36.5 [16.6]

Note: Contact factory for dimensions on flanged or union models. [†]Varies with motor manufacturer ^{*}Does not include motor weight

^{**}For B5 weight, add 3 lbs. to 80/90 B14 frame weight and 6 lbs. to 100/112 B14 frame weight.

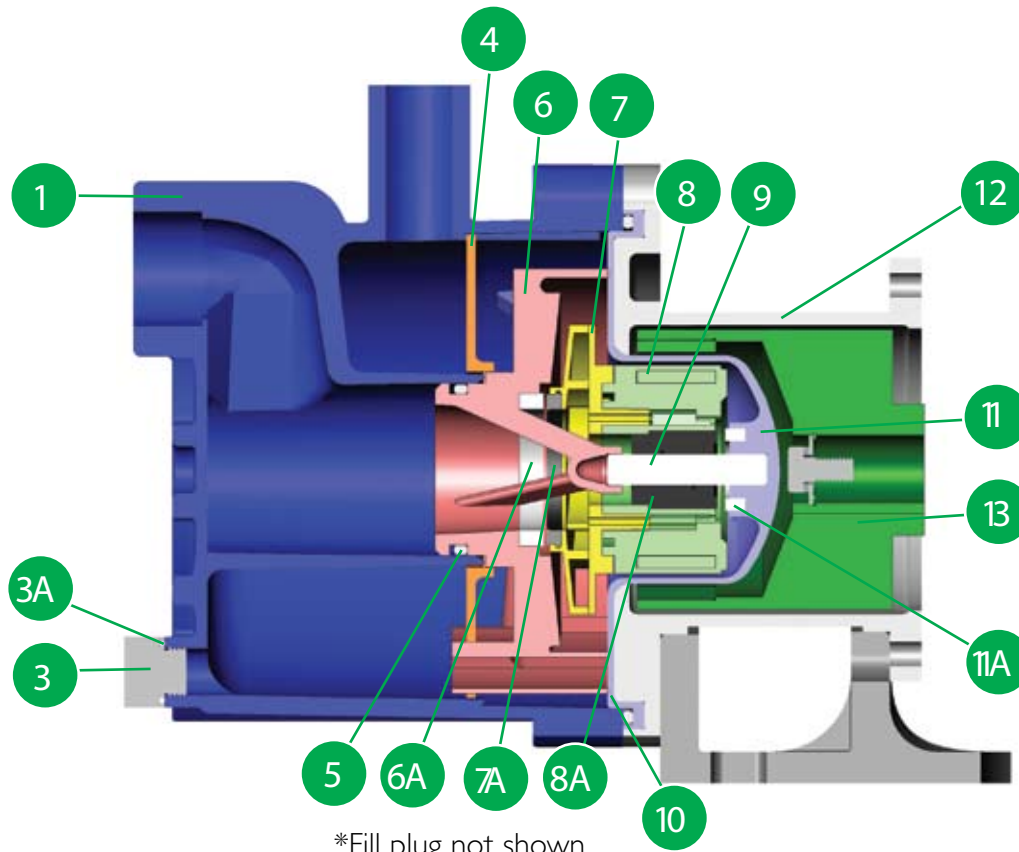

*Fill plug not shown

Description	Polypropylene Models	PVDF Models
1	Housing	
4	Separator plate	Glass-fiber reinforced polypropylene
6	Inner volute	Carbon-fiber reinforced PVDF
7	Impeller	
3A, 5, 10	O-ring options	FKM, EPDM
3	Fill and drain plugs*	Polypropylene
		PVDF
6A	Inner volute thrust ring options	High purity alumina ceramic, silicon carbide
7A	Impeller thrust washer options	Molybdenum disulfide filled PTFE, silicon carbide
8	Inner drive	Neodymium iron boron magnets encapsulated in unfilled polypropylene
		Neodymium iron boron magnets encapsulated in unfilled PVDF
8A	Bushing options	Carbon, PTFE, high purity alumina ceramic, silicon carbide
9	Shaft options	High purity alumina ceramic, Hastelloy® C, silicon carbide
11	Barrier	Glass-fiber reinforced polypropylene
		Carbon-fiber reinforced PVDF
11A	Barrier thrust ring	High purity alumina ceramic
12	Motor adapter	Ductile iron
13	Outer drive magnets	Nickel-plated neodymium iron boron magnets/steel

Hastelloy® C is a registered trademark of Haynes International, Inc.

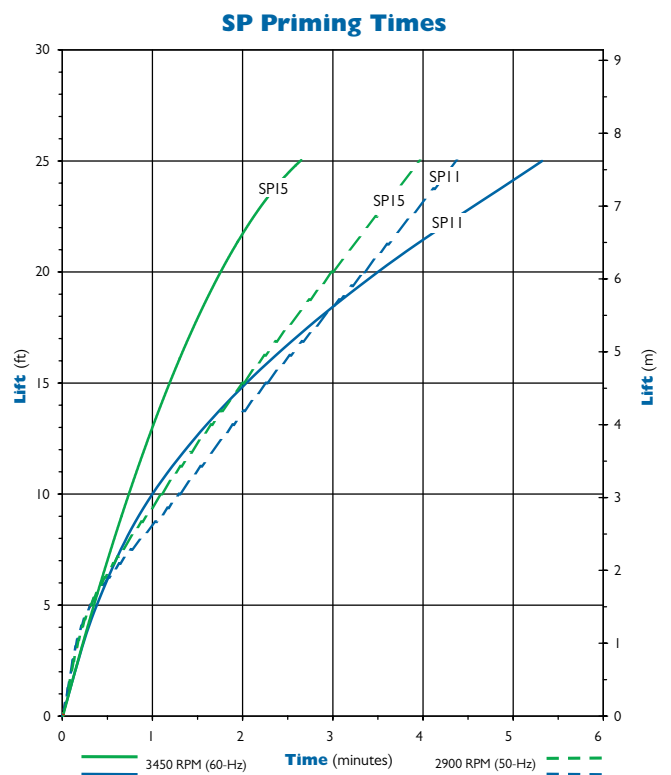

SP Series: Model SP11

SPII PERFORMANCE - Flooded Suction - 3450 RPM

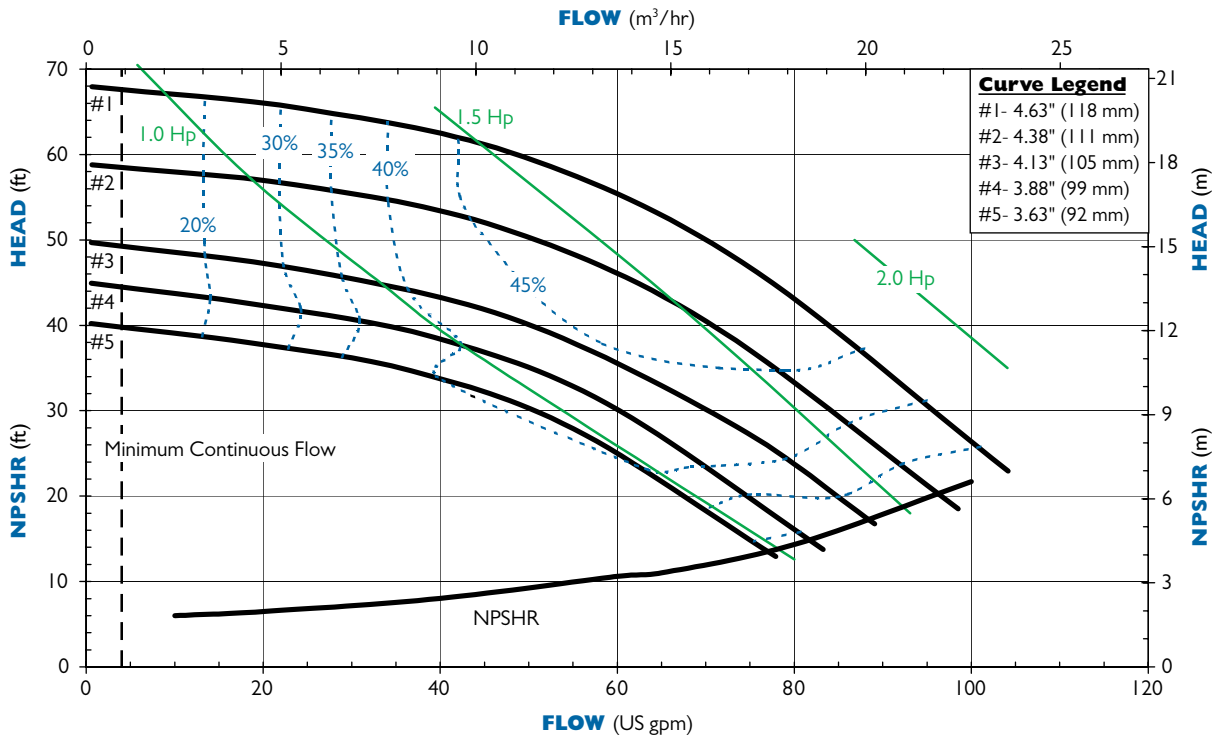

SPII PERFORMANCE - Flooded Suction - 2900 RPM

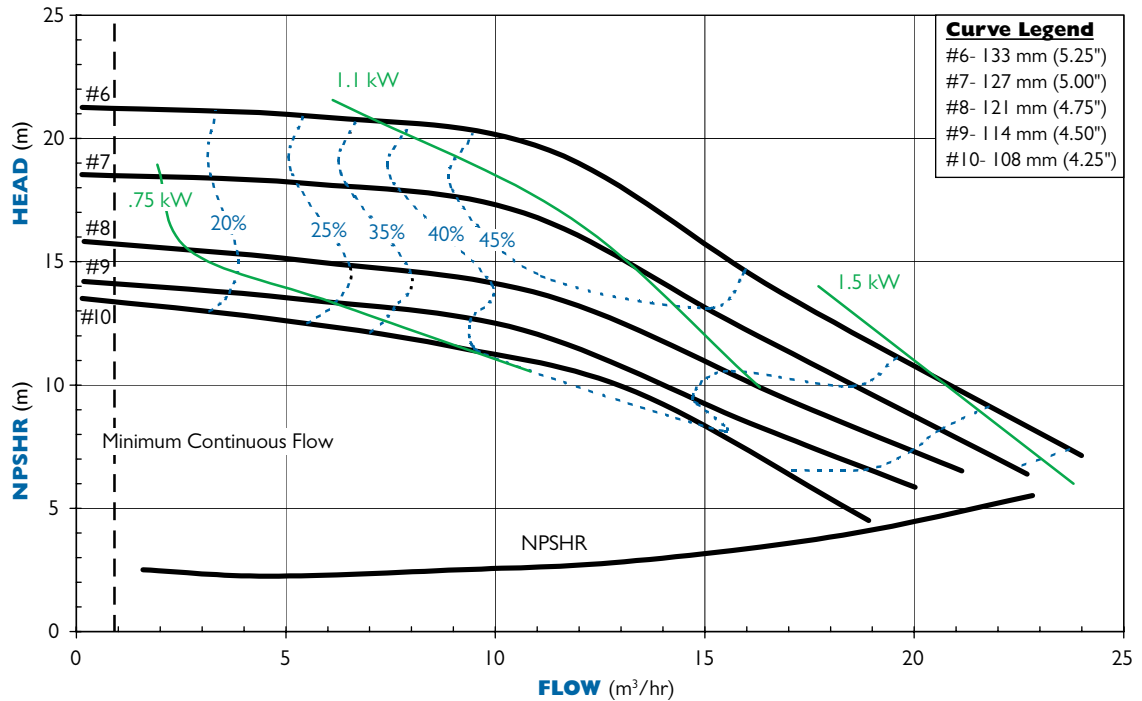

Curves based on flooded suction. Performance will vary with lift. To view curves with various suction lift conditions, contact factory or download from FTI website.

SP Series: Model SP15

SP15 PERFORMANCE - Flooded Suction - 3450 RPM

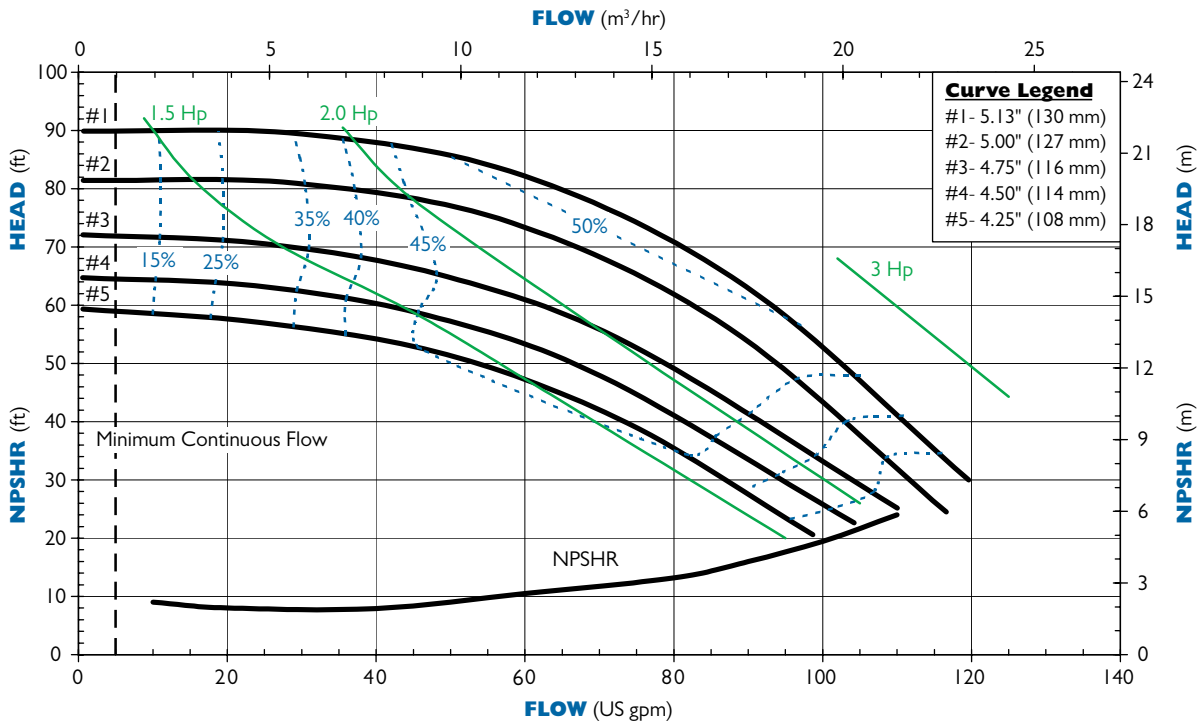

SP15 PERFORMANCE - Flooded Suction - 2900 RPM

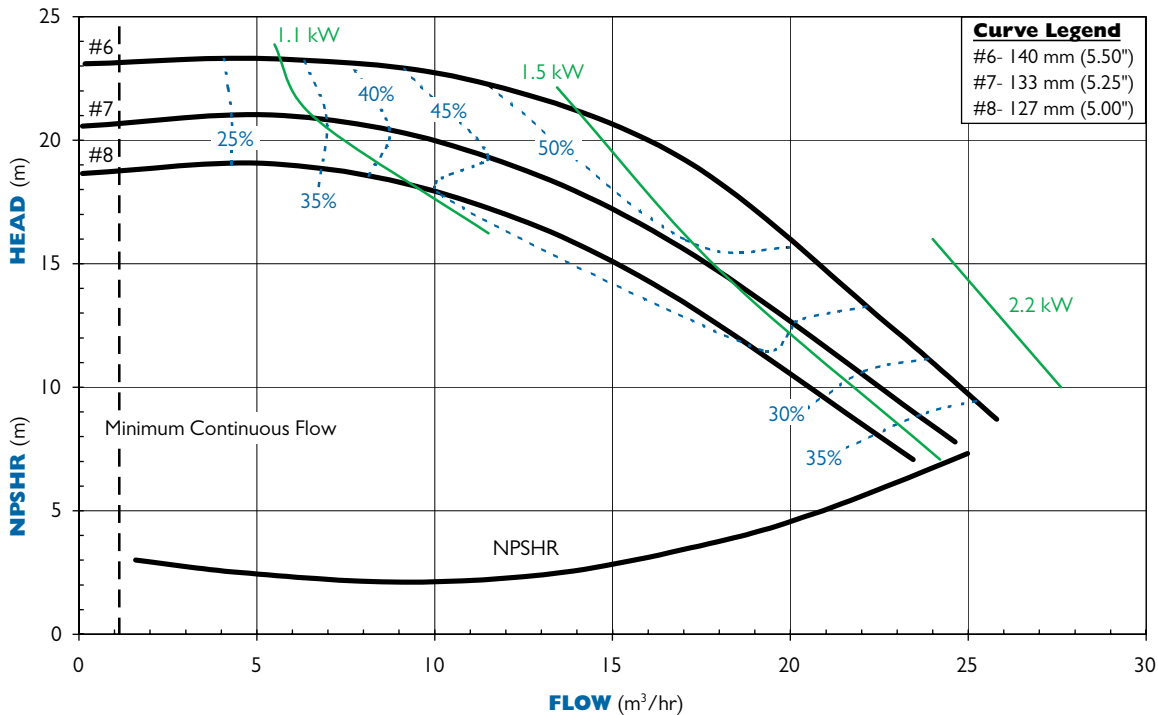

Curves based on flooded suction. Performance will vary with lift. To view curves with various suction lift conditions, contact factory or download from FTI website.



Only from Finish Thompson.



*Looking for end suction pumps? Ask about our DB Series.
Pick the perfect pump. Visit our online pump selector at finishthompson.com.*



FINISH THOMPSON INC.

921 Greengarden Road • Erie, PA 16501-1591 U.S.A.
Ph 814-455-4478 • Fax 814-455-8518
Email fti@finishthompson.com • www.finishthompson.com

FT06-938